

SONOS

1L-17HU-20

1 / 15

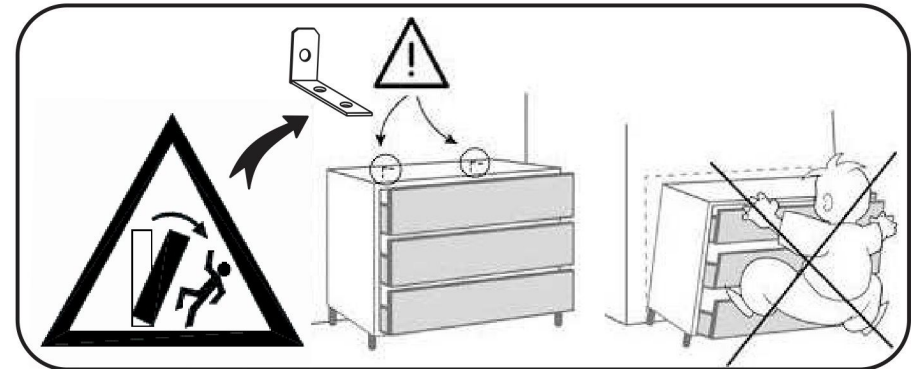

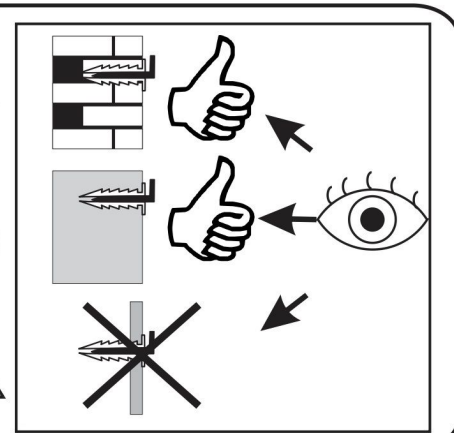
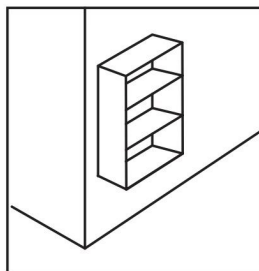
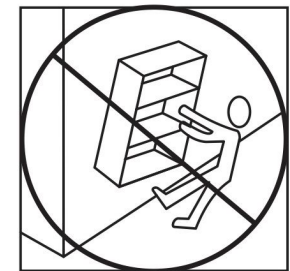
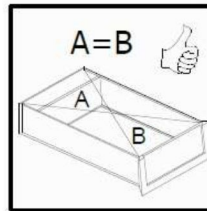
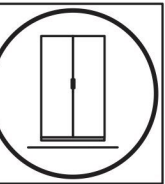
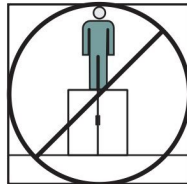
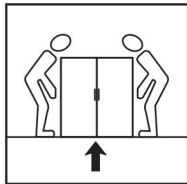
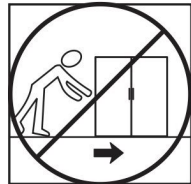
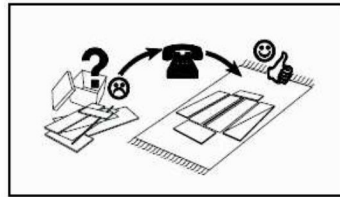
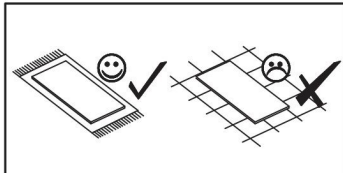
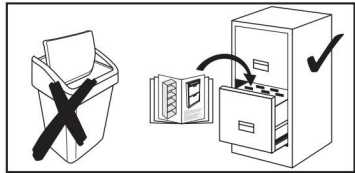
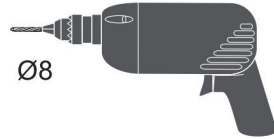
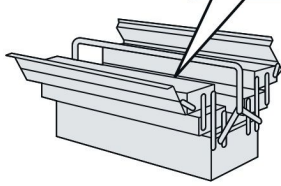
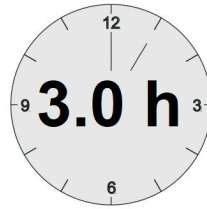
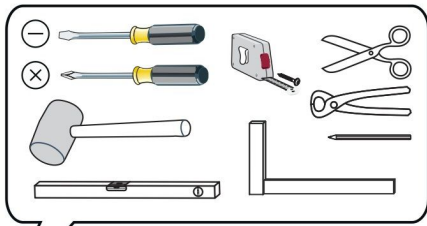
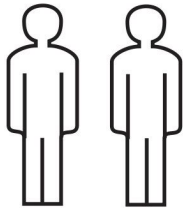
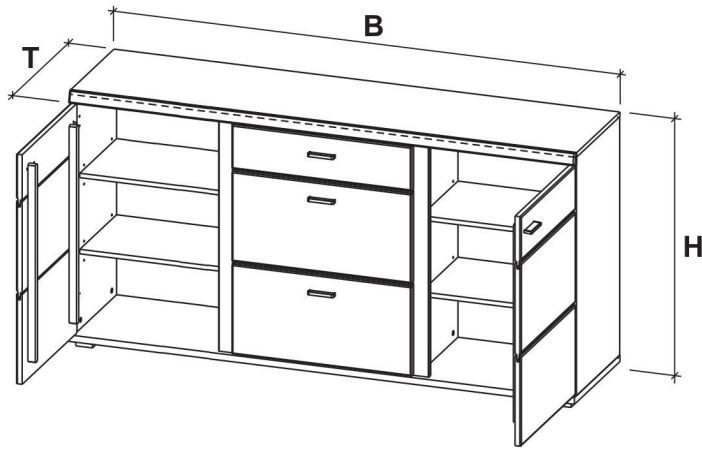

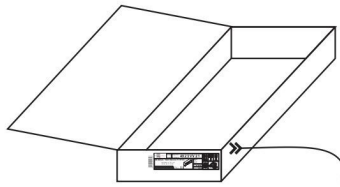
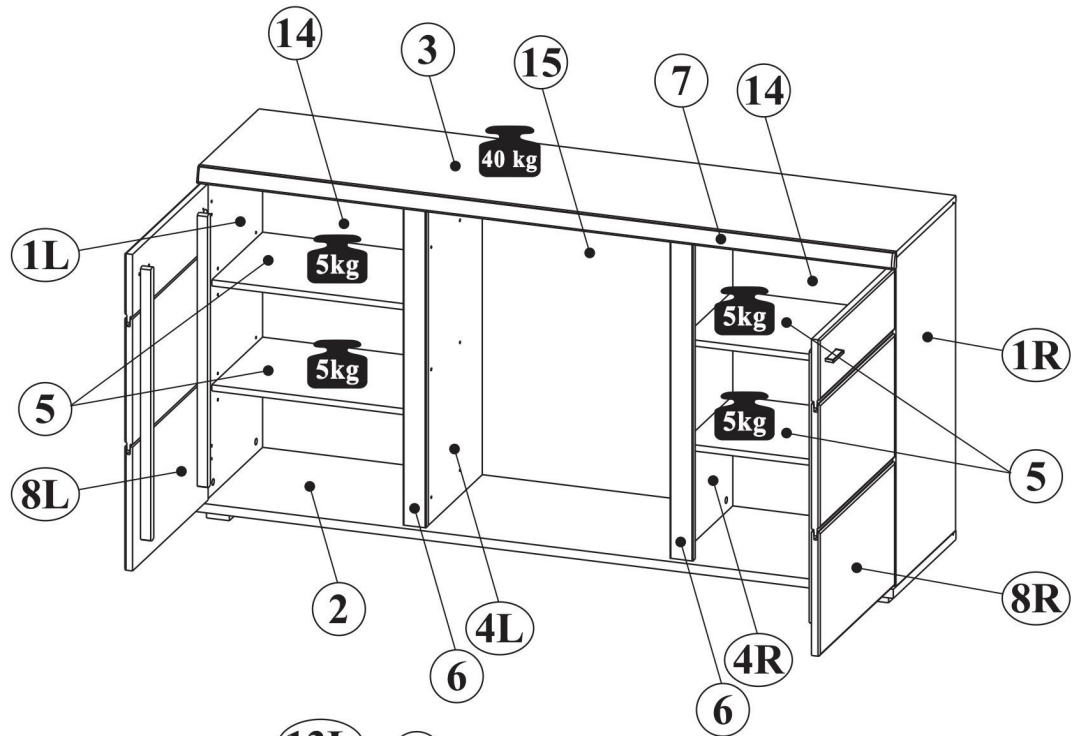

B - 1700mm
H - 859mm
T - 420mm



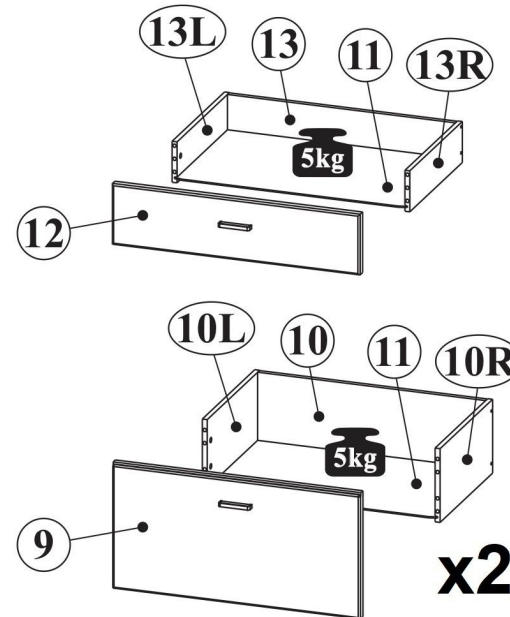

1L,1R	802	398	2	2
2	1699	420	1	3
3	1699	398	1	3
4L,4R	802	362	2	2
5	520	340	4	1,3
6	802	55	2	3
7	1701	40	1	3
8L,8R	506	772	2	1
9	604	307	2	1
10L,10R	352	180	4	2
10	555	180	2	2
11	565	349	3	2
12	604	148	1	1
13L,13R	352	100	2	2
13	555	100	1	1
14	812	533	2	1
15	812	610	1	1





NR 1

B1  ϕ 8x30 x42

M1  ϕ 15x12mm x22

T1  x32

W1  x16

F33  x6

P13  3,5x13 x24

NR 2

C14  x26

J23  x18

F1  x6

P2  3x20 x6

C15  x12

NR 3

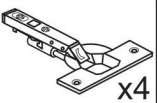
X11  x4

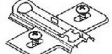
PH  x4

S8  3,5x13 x8

NR 4

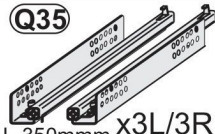
Q35  L-350mm x3L/3R

E24  6x8 x12

M2  ϕ 15x10mm x10

P5  3,5x30 x12

F338  L-338 x3

P10  3x13 x6

S4  3x16 x6

S3  3,5x13 x12

NR 5

N20  x6

S2  4x30 x24

NR 6

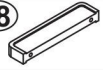
U188  x5

A2  M4x25 x10

NR 7

J11  x2

P13  3,5x13 x4

T13  8x50 mm x2

T14  6x50 mm x2

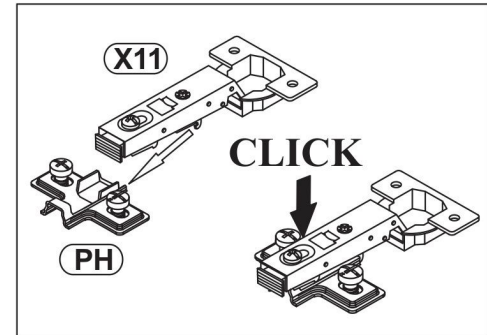
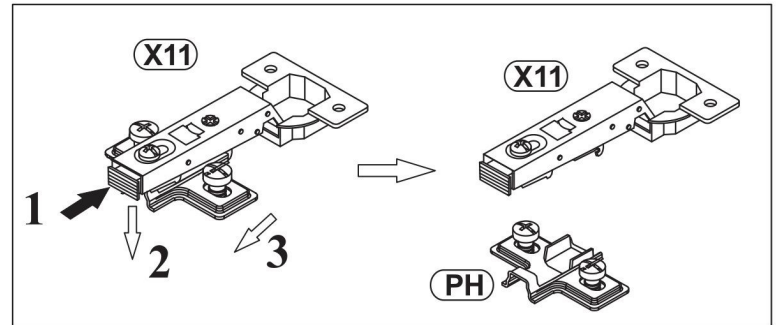

1

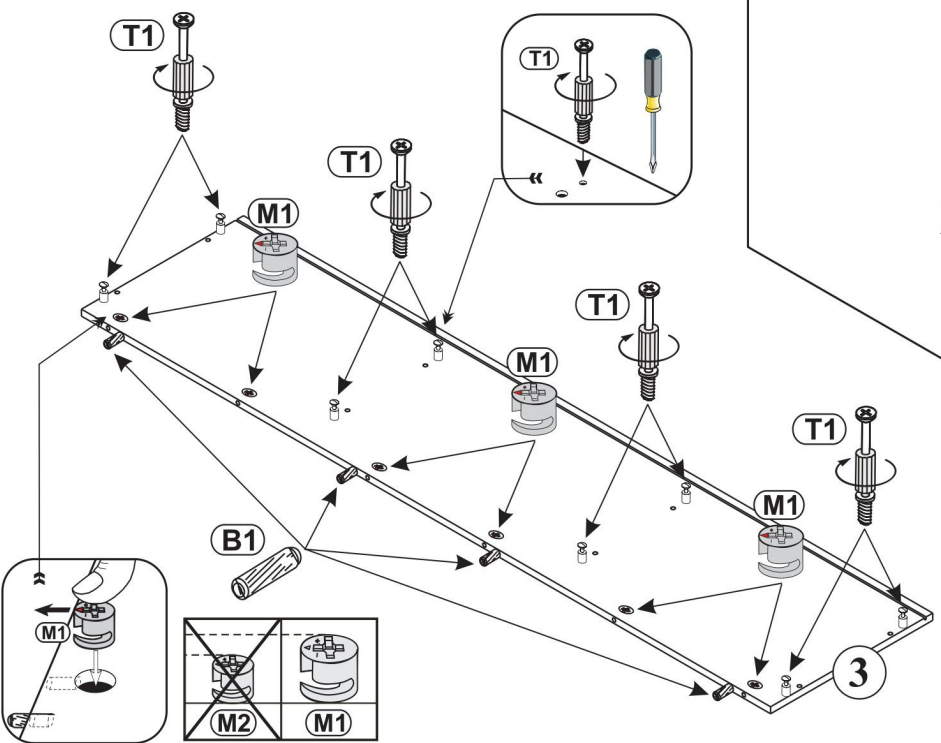
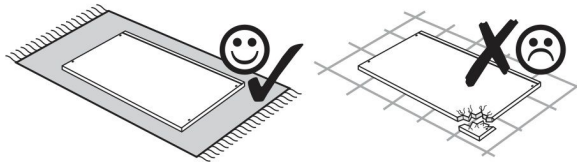
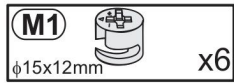
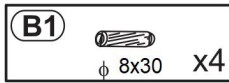
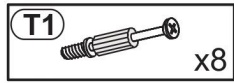

2

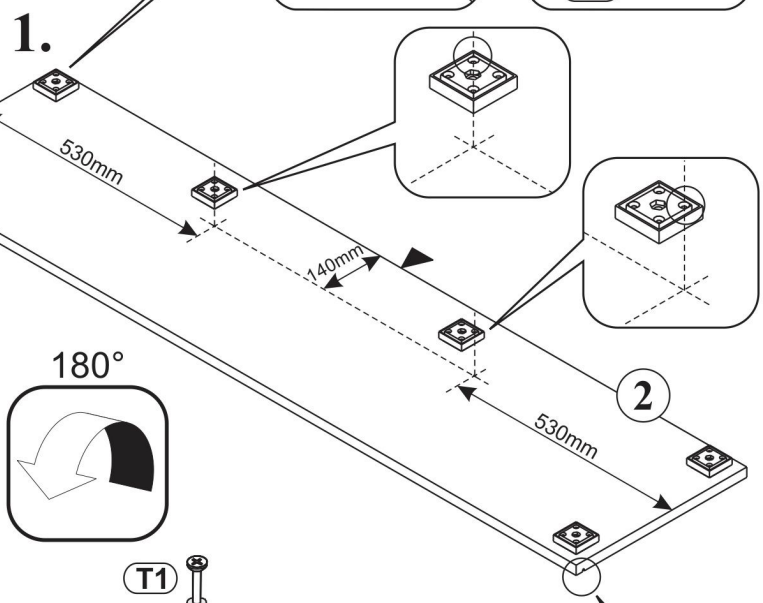
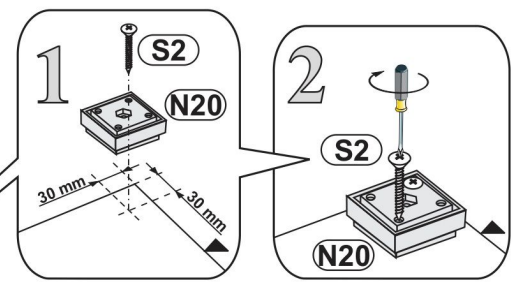
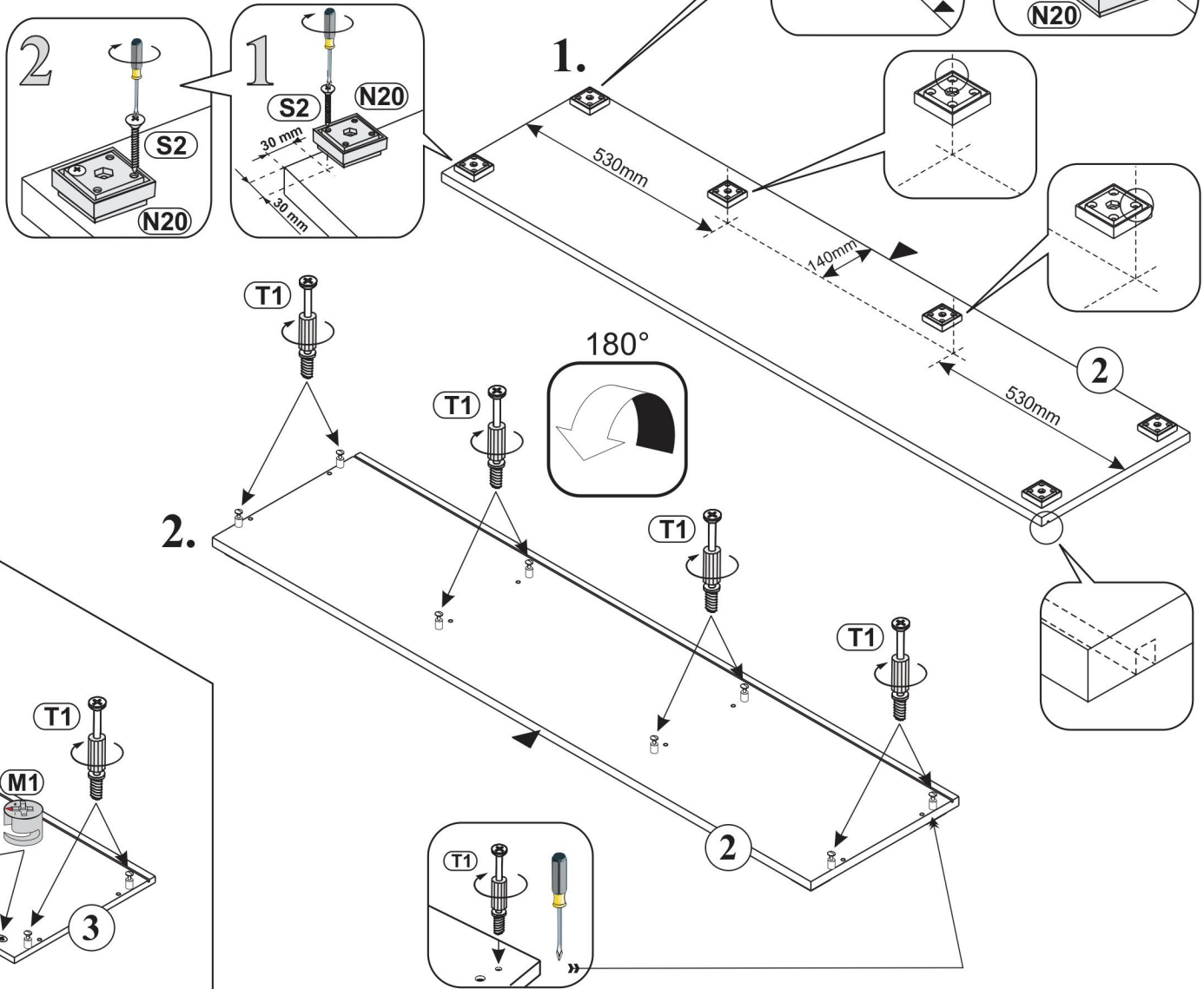
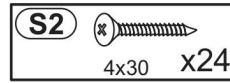
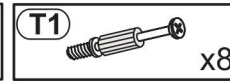
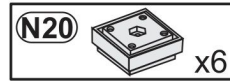

3

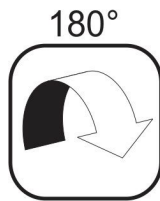
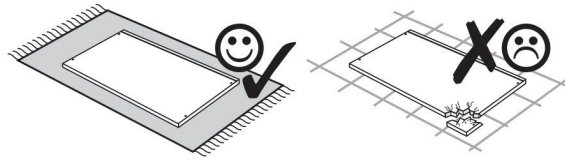
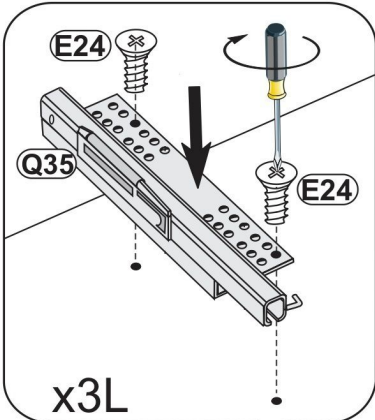
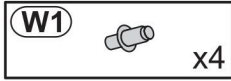
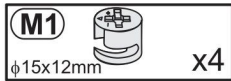
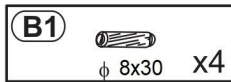
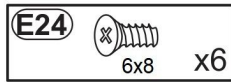
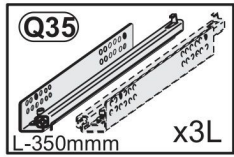

1.

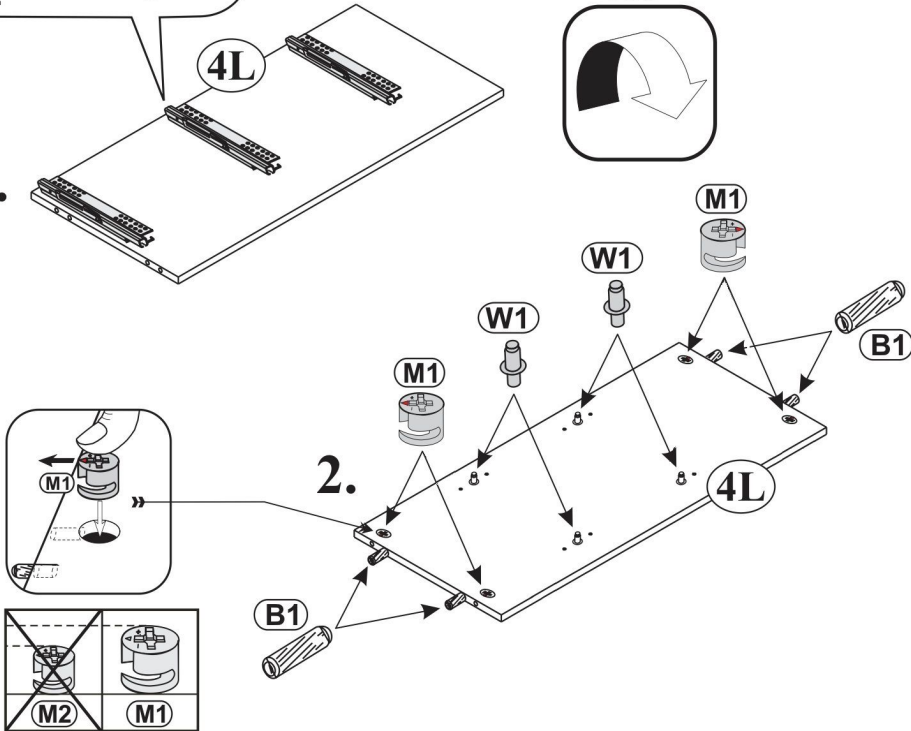

4

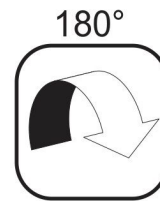
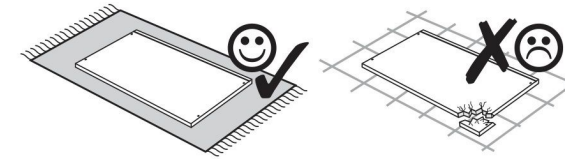
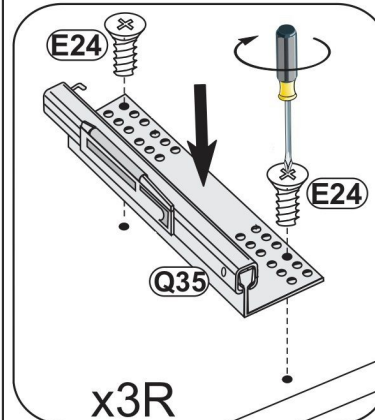
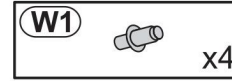
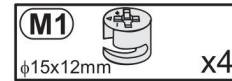
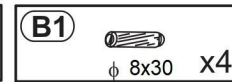
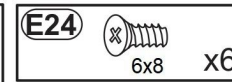
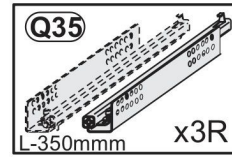

1.

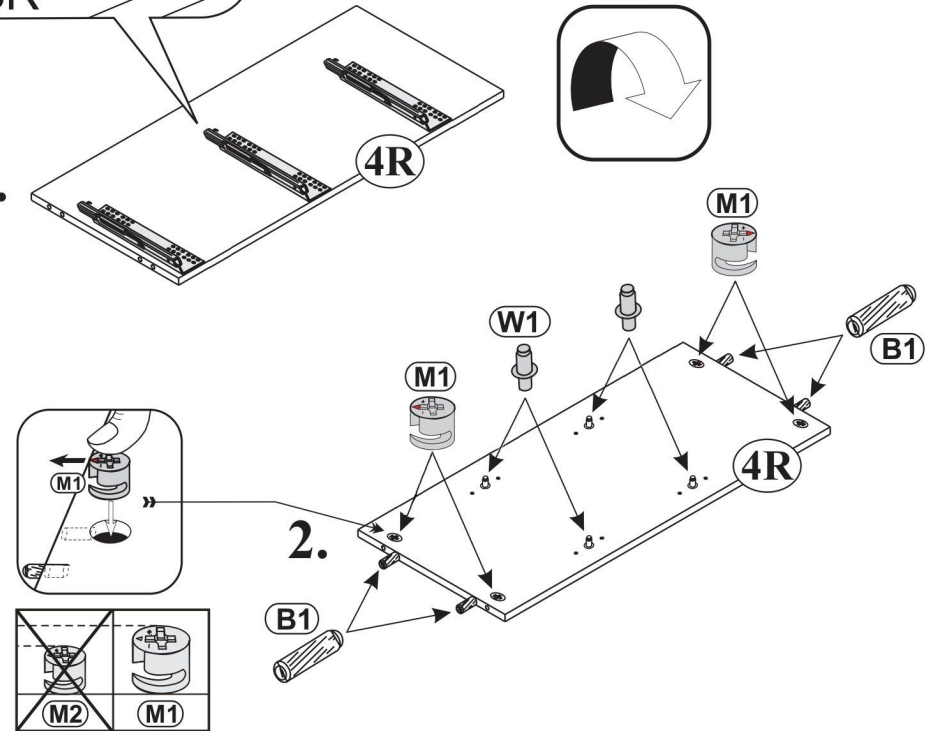

5

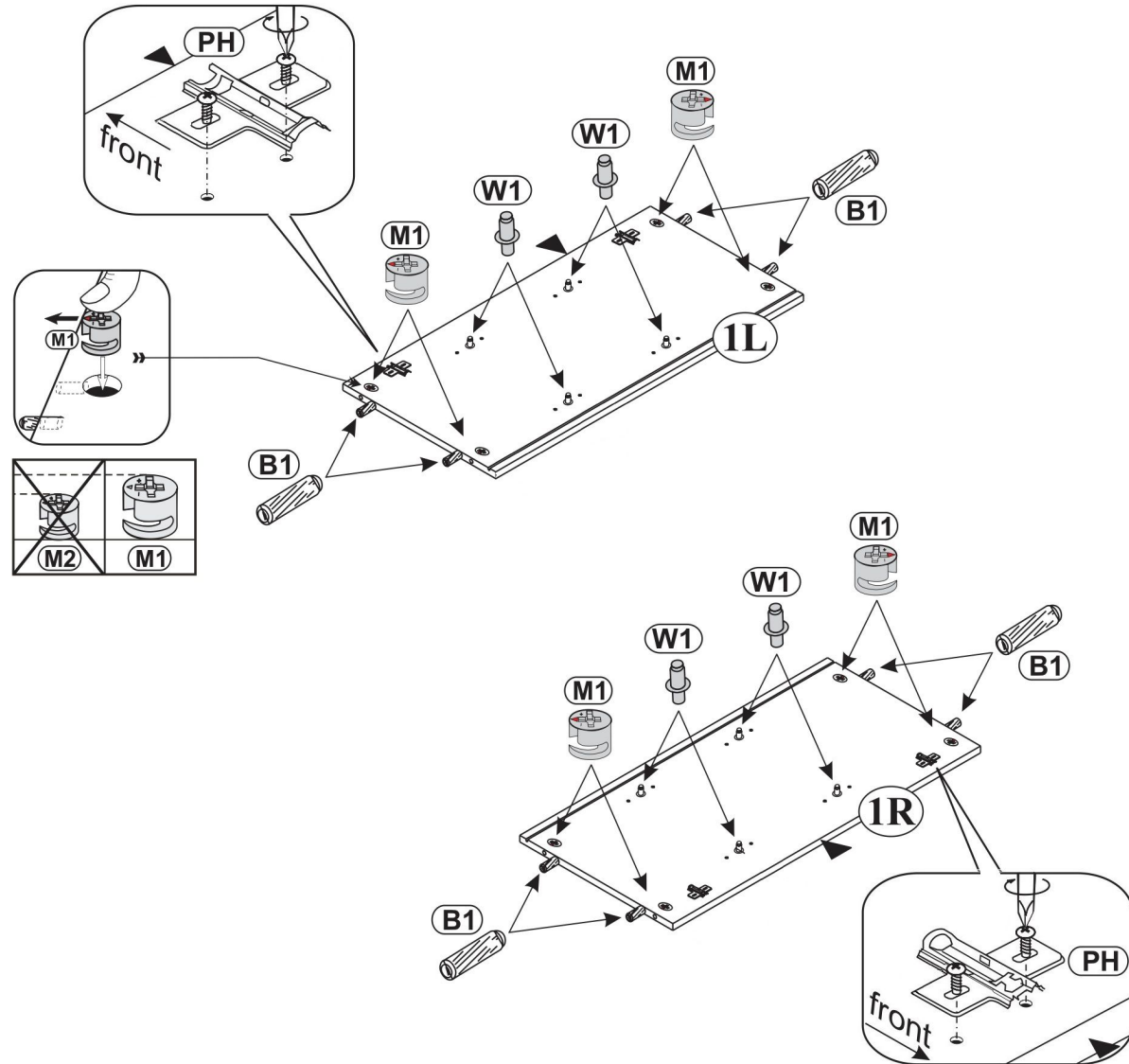
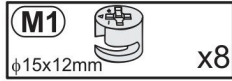
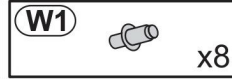
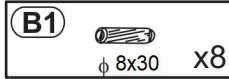
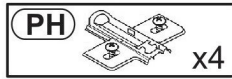

6

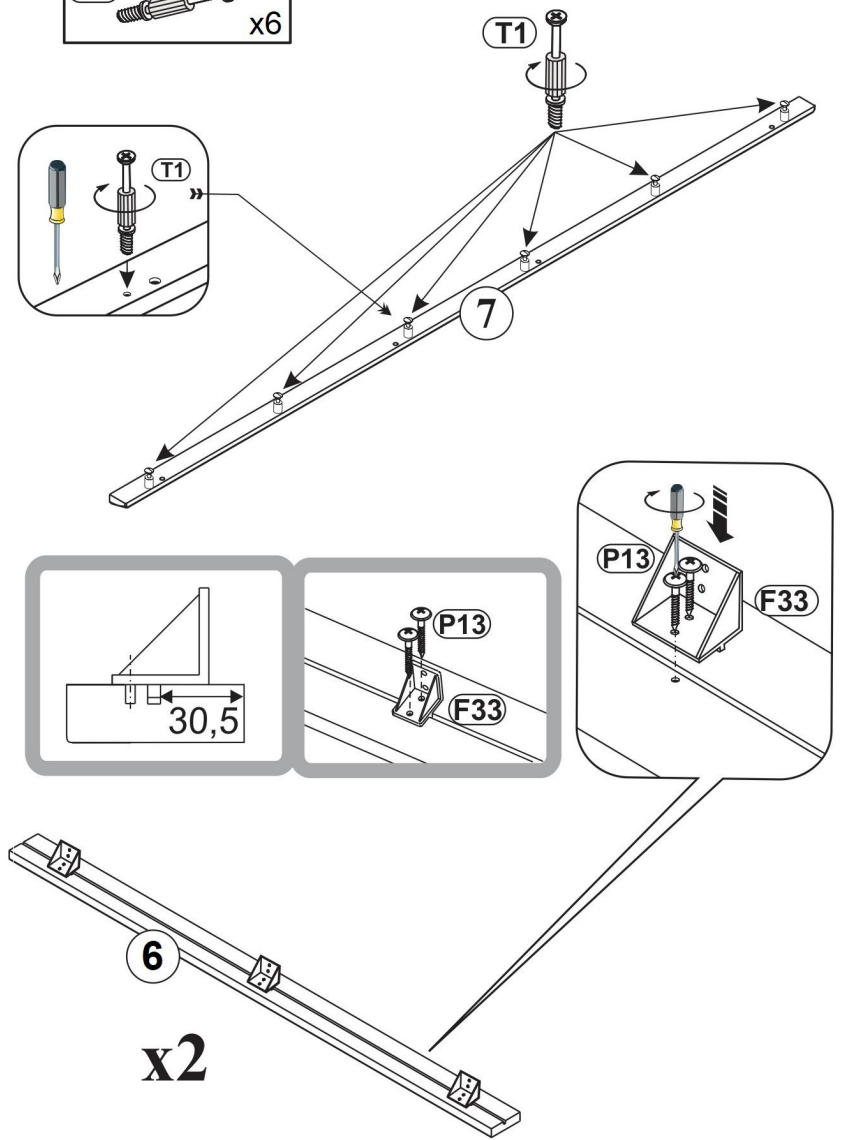
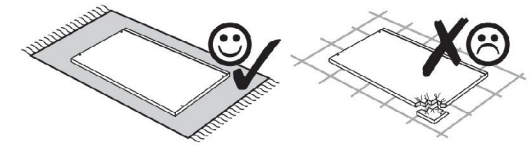
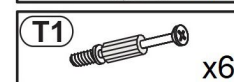
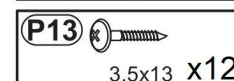
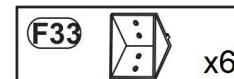

7

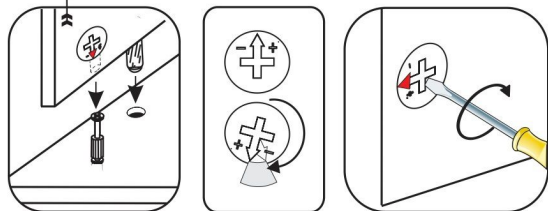
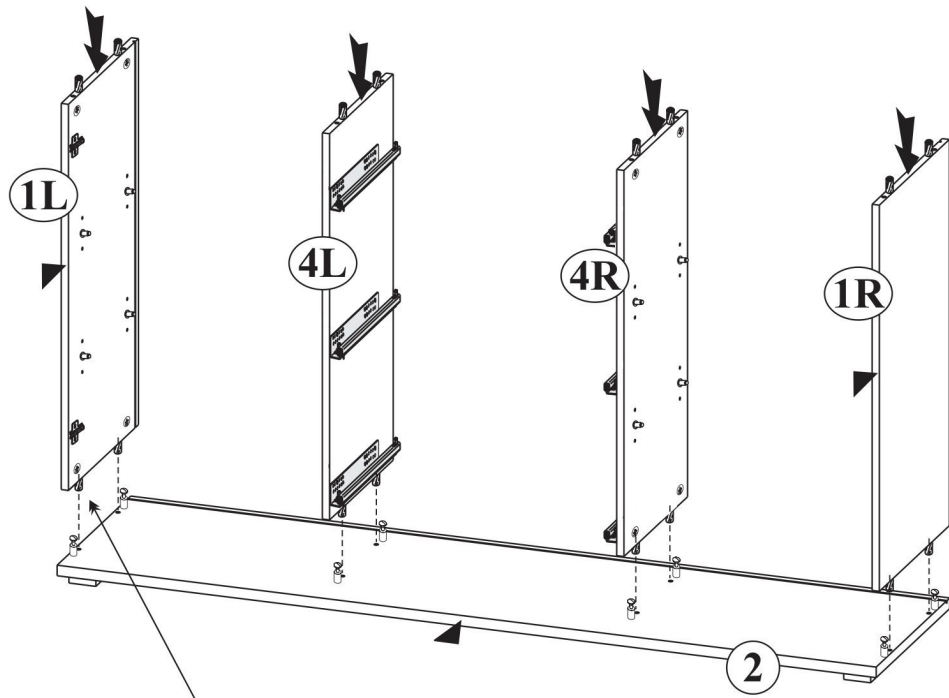

8

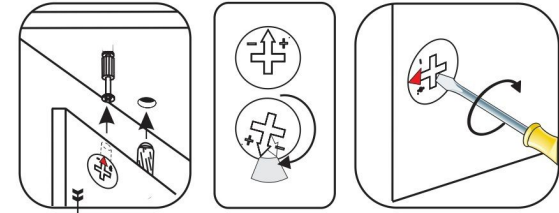
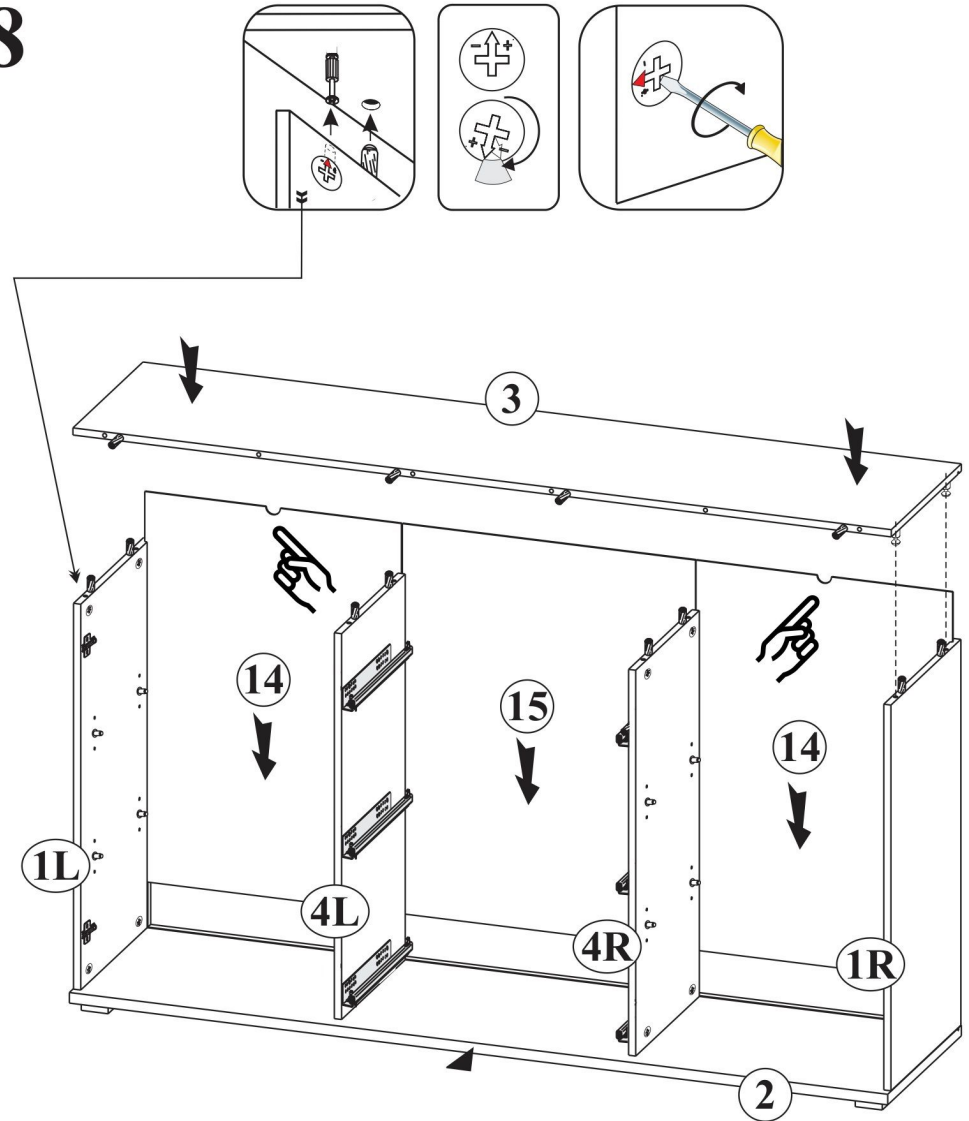

9

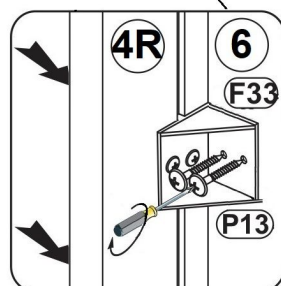
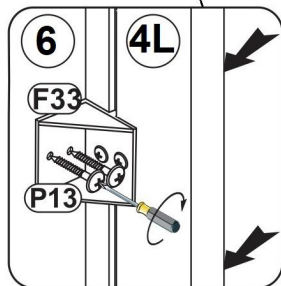
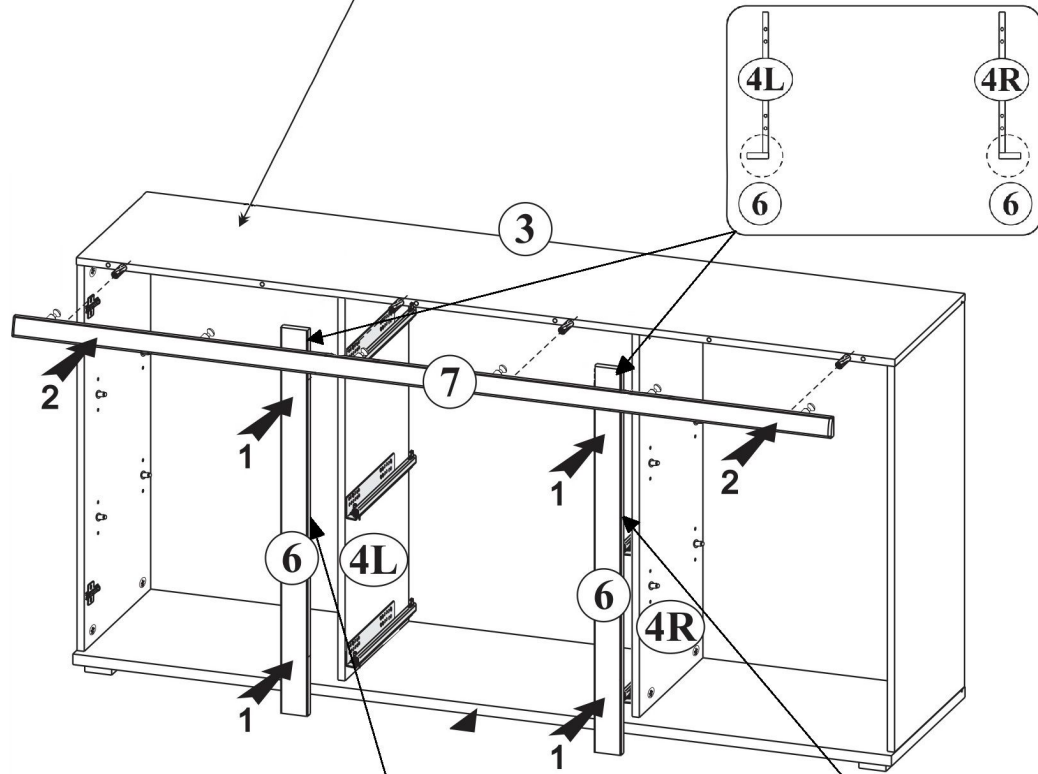
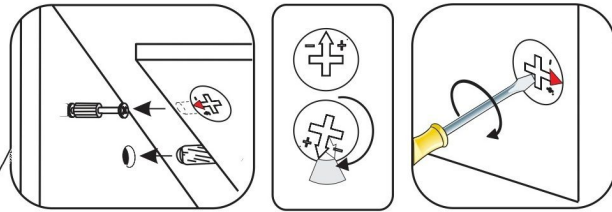
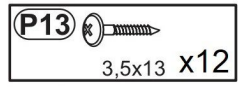

10

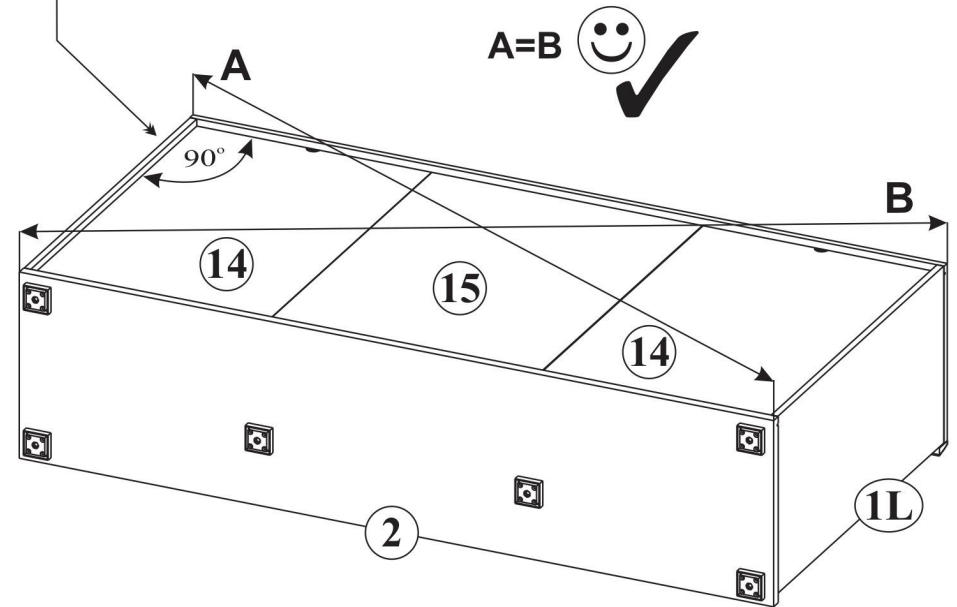
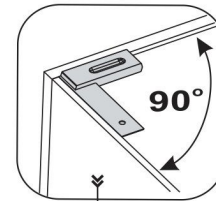
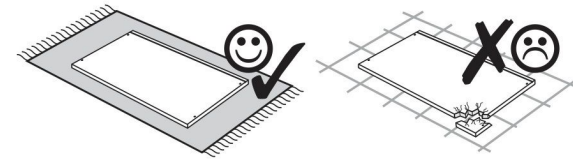

11

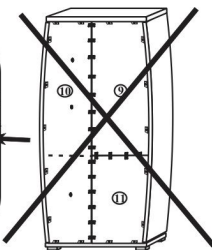
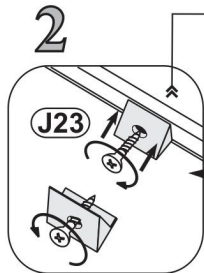
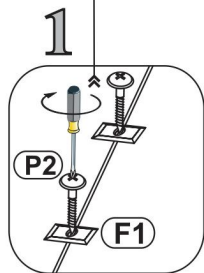
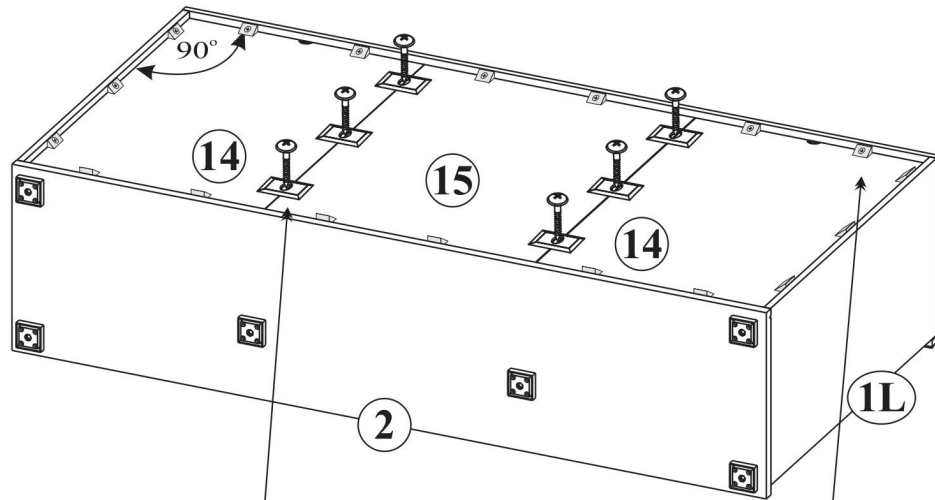
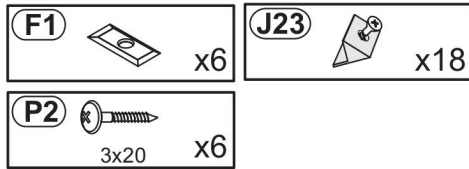

12

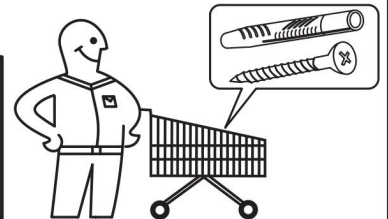
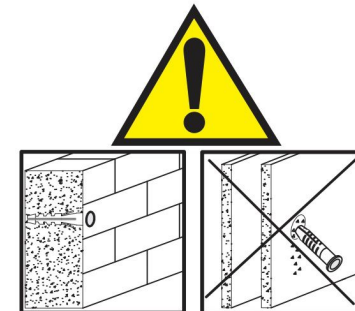
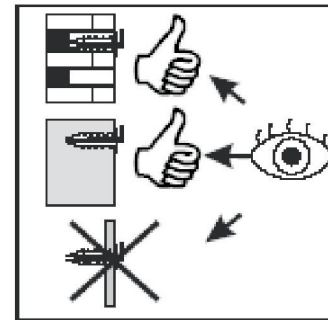
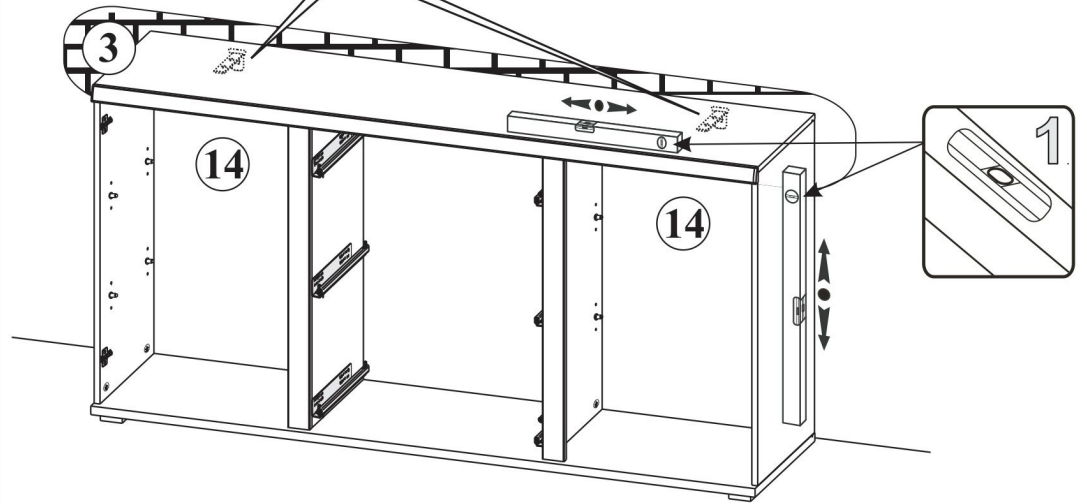
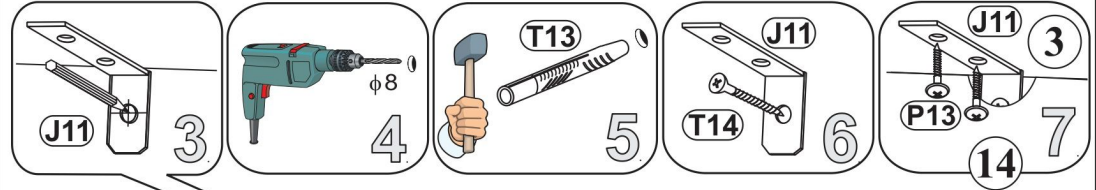
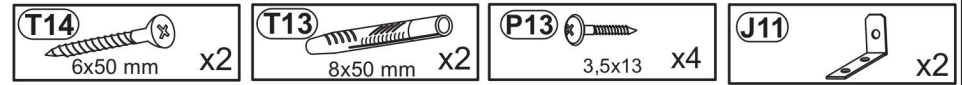

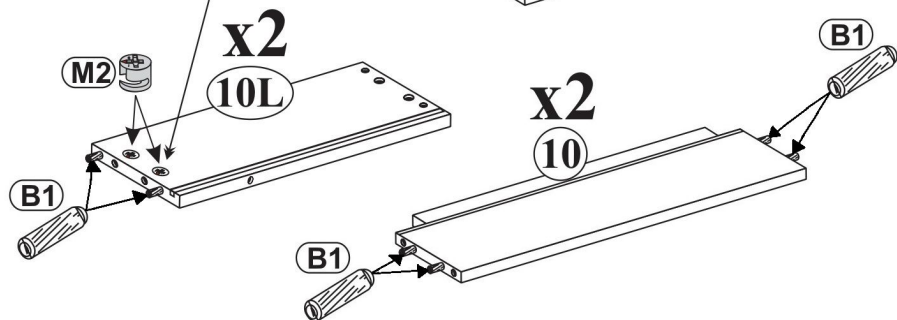
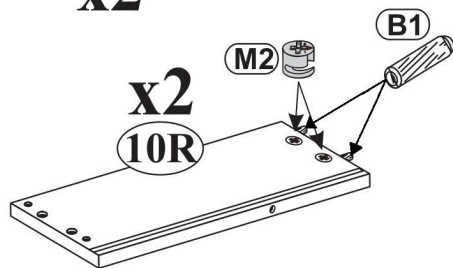
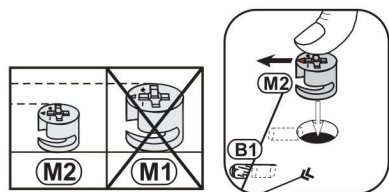
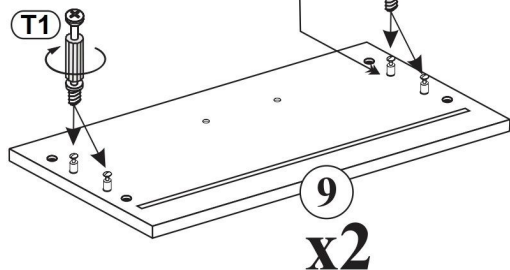
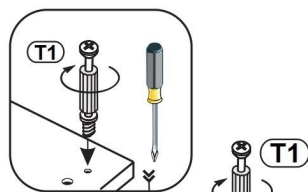
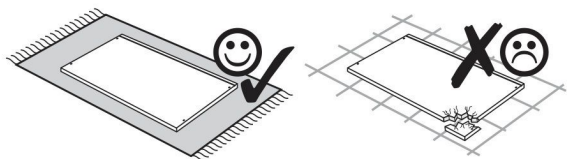

13

- M2**  x8
- T1**  x8
- B1**  ϕ 8x30 x16



14

- P5**  3,5x30 x8
- F338**  L-338 x2
- P10**  3x13 x4

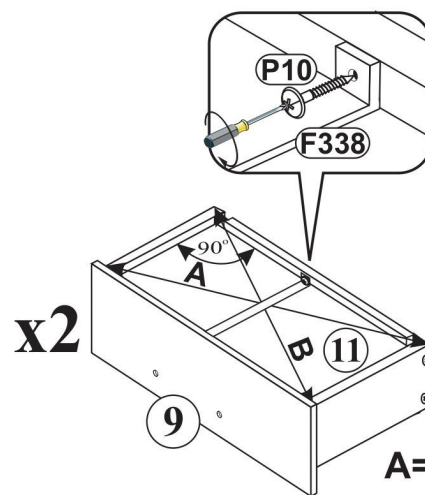
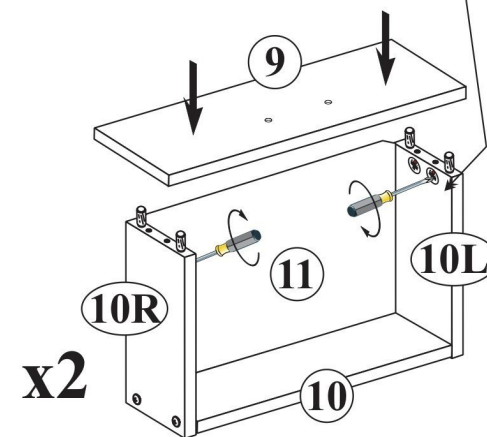
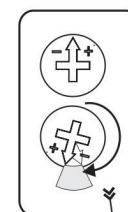
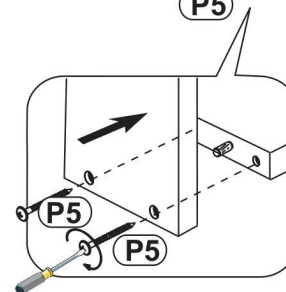
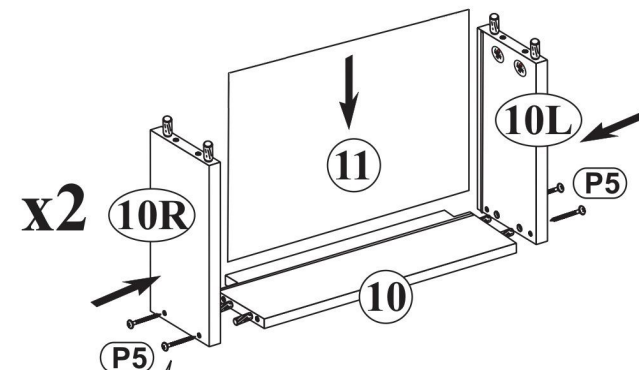

A=B 

15

- M2** $\phi 15 \times 10 \text{mm}$ x2
- T1** x2
- B1** $\phi 8 \times 30$ x6

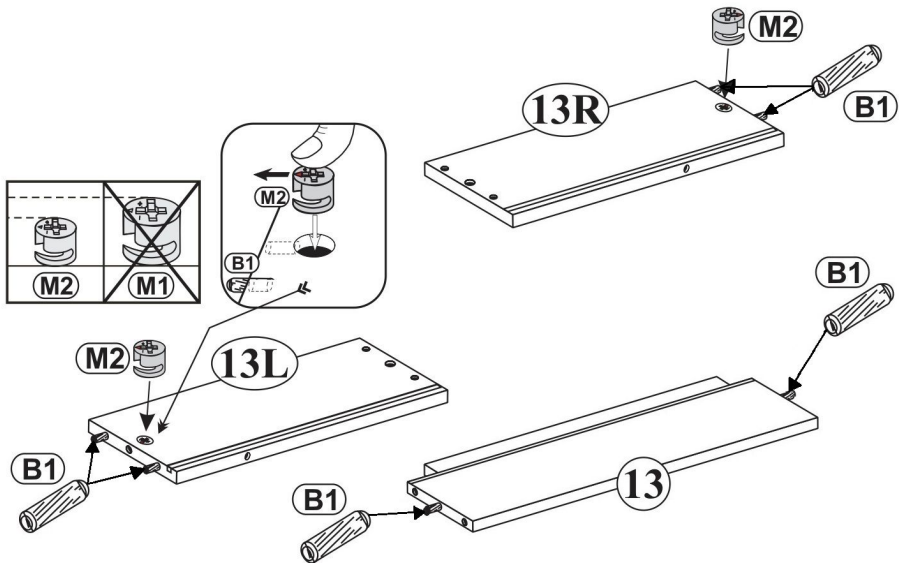
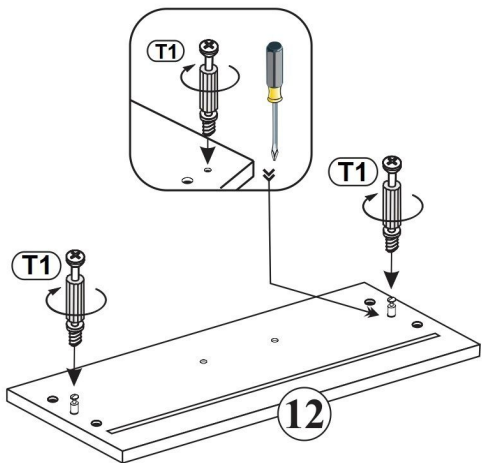
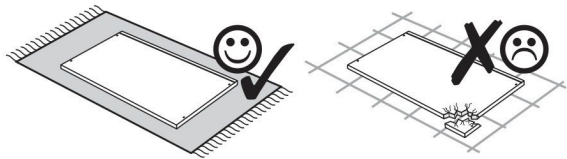

16

- P5** 3,5x30 x4
- F338** L-338 x1
- P10** 3x13 x2

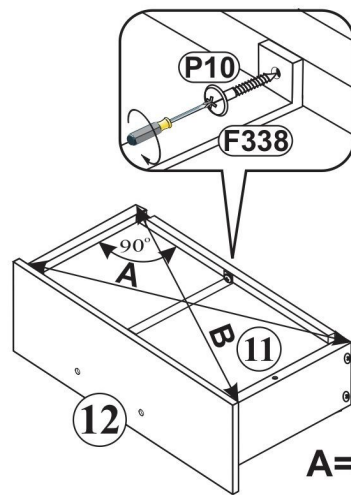
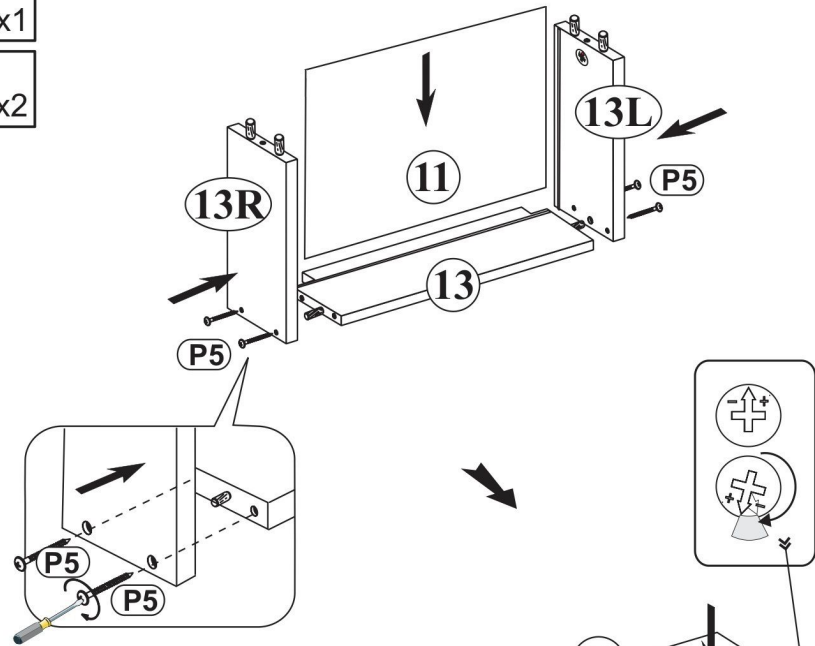

A=B ☺ ✓

17

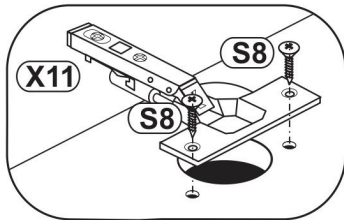
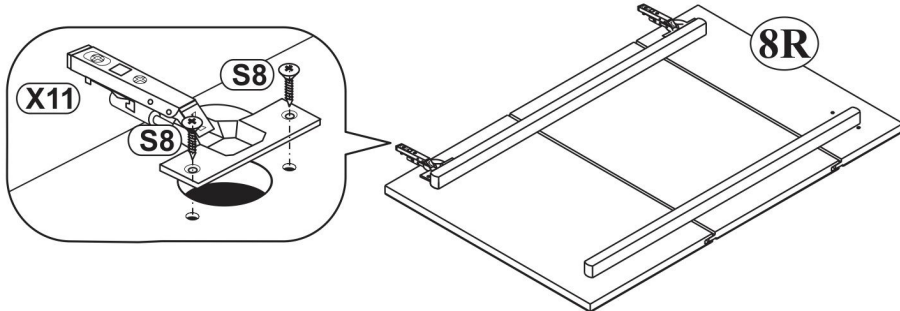
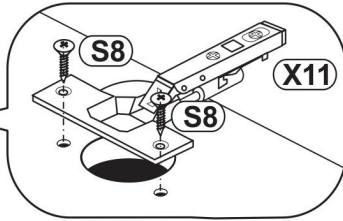
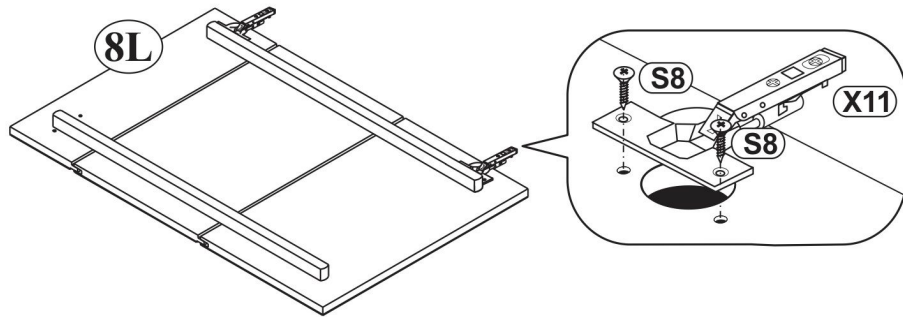
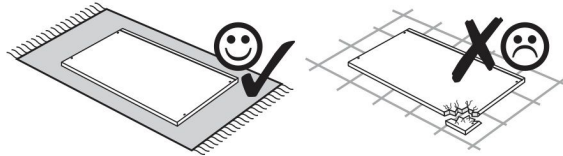
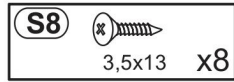
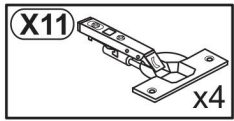

18

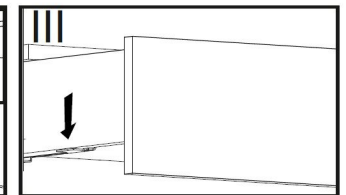
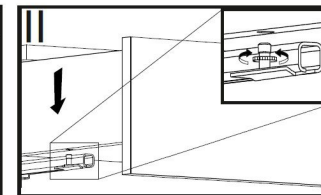
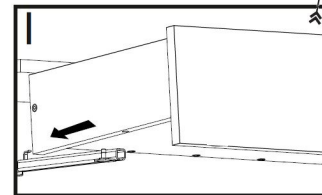
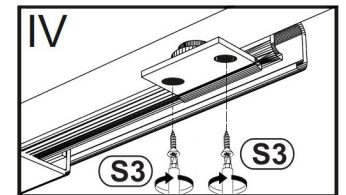
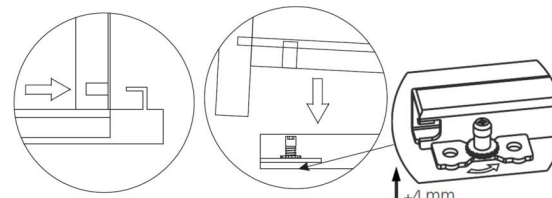
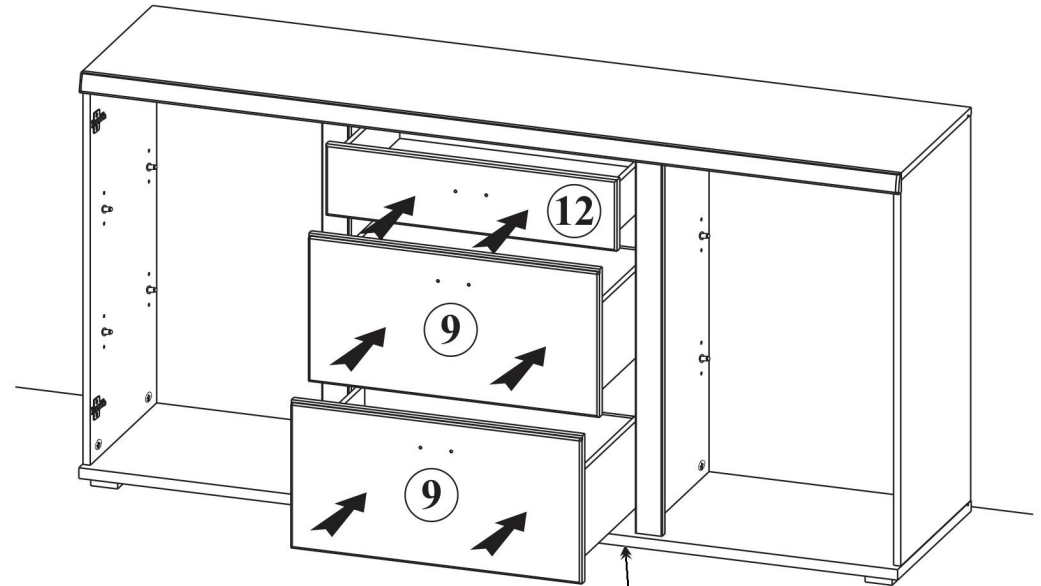
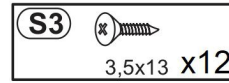

19

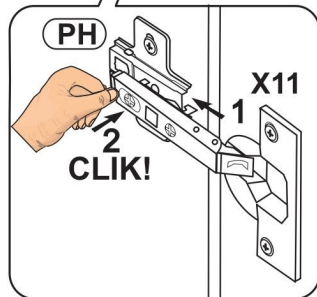
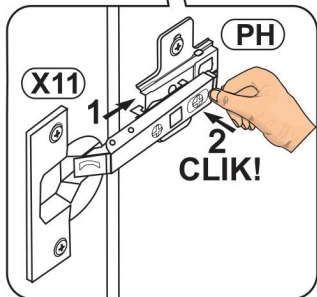
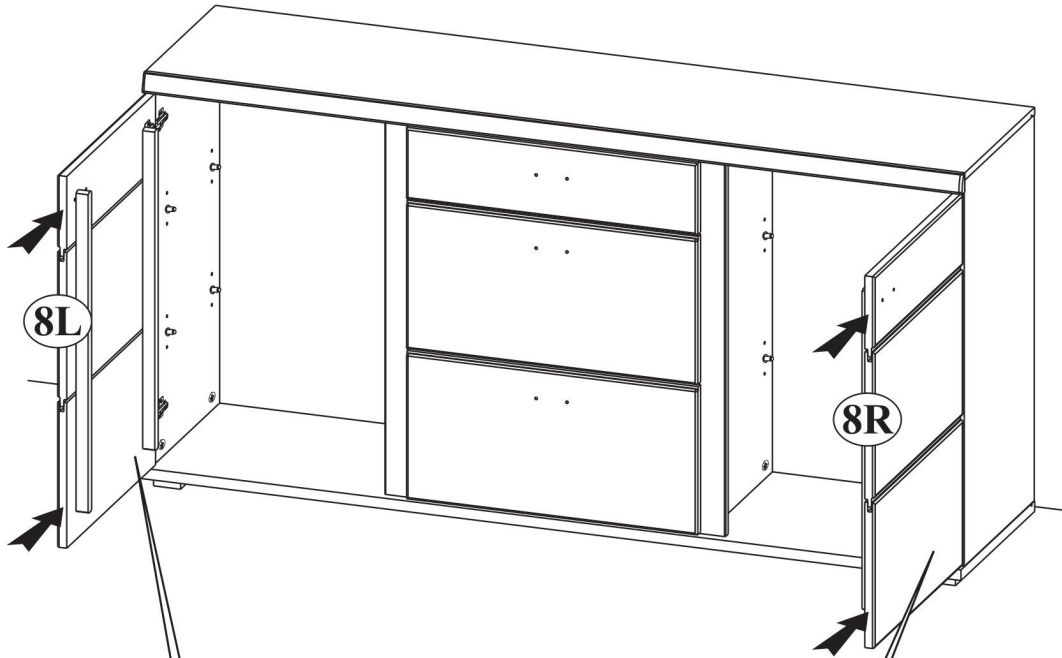

20

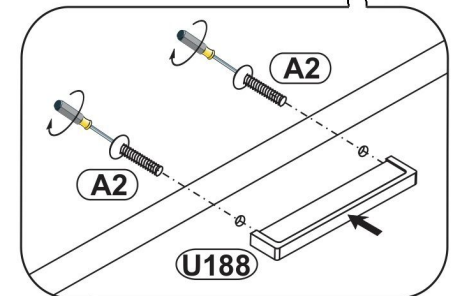
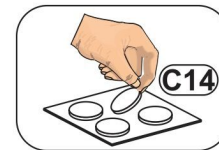
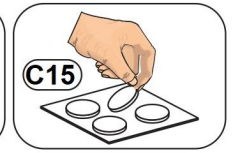
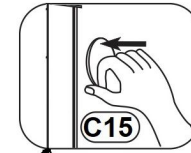
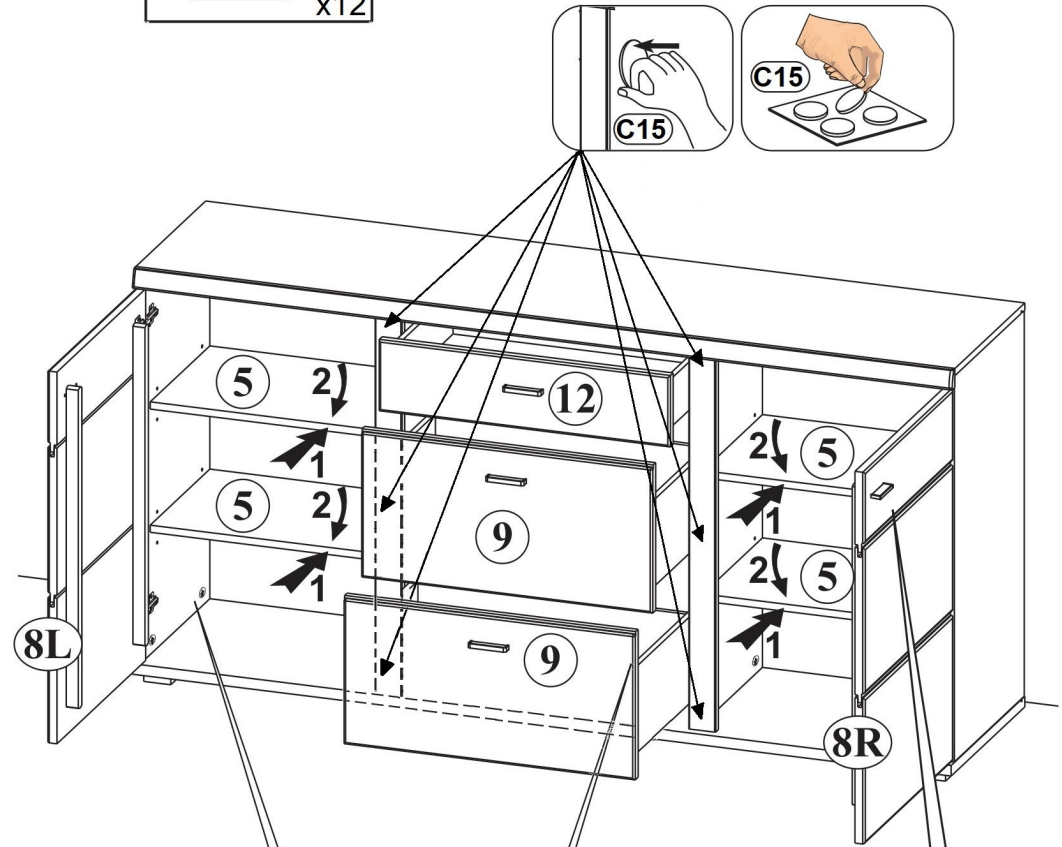
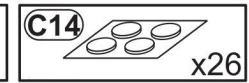
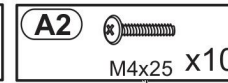
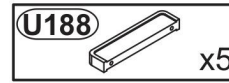

21

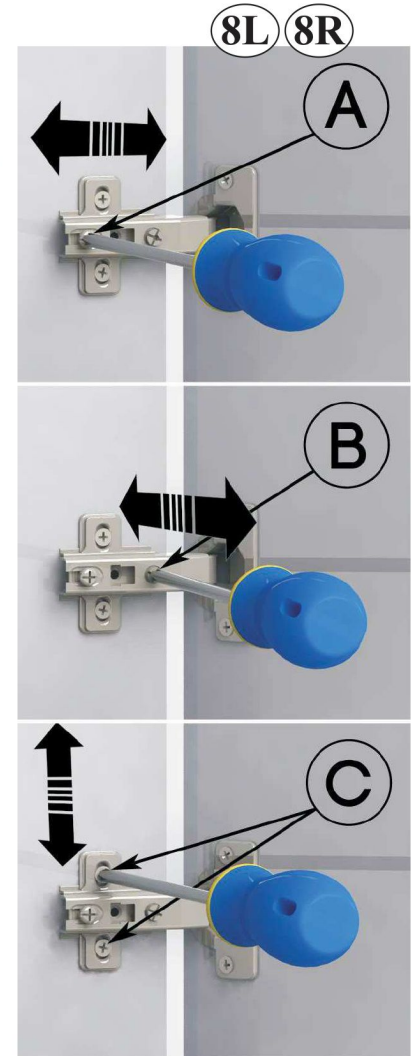
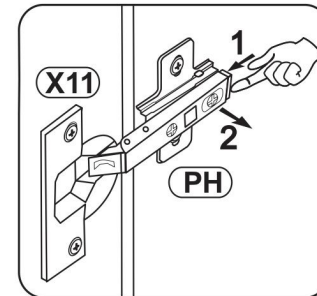
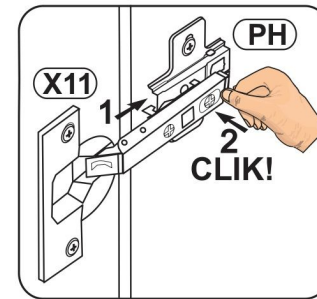
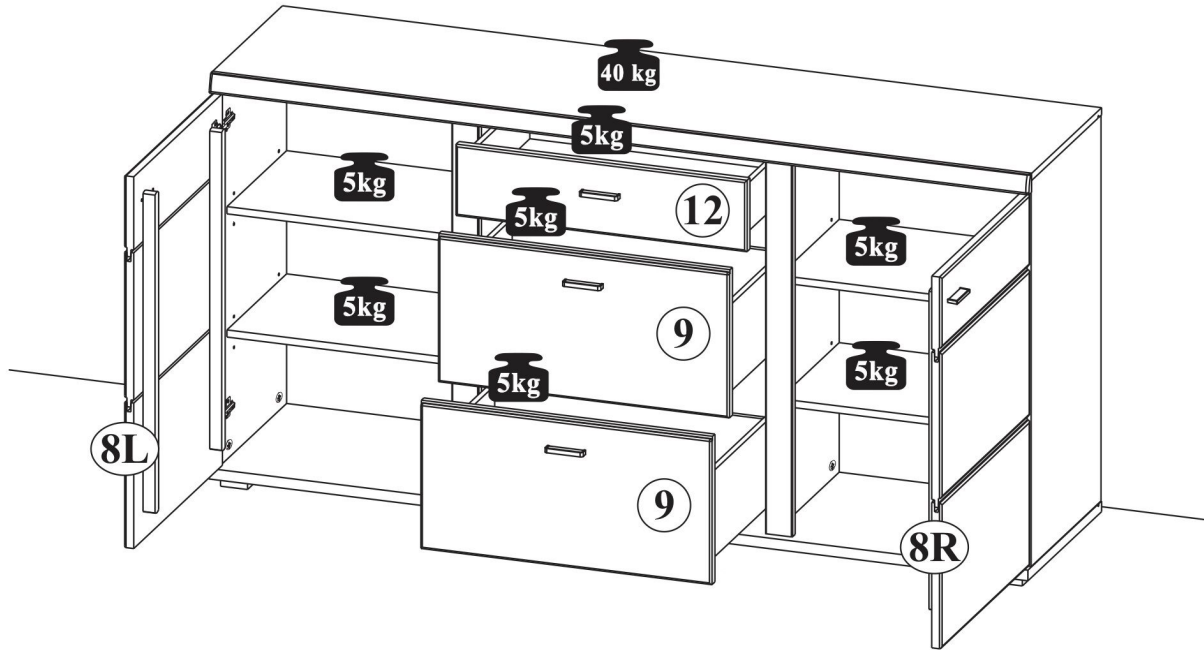
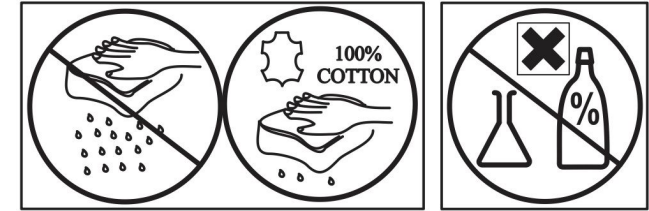

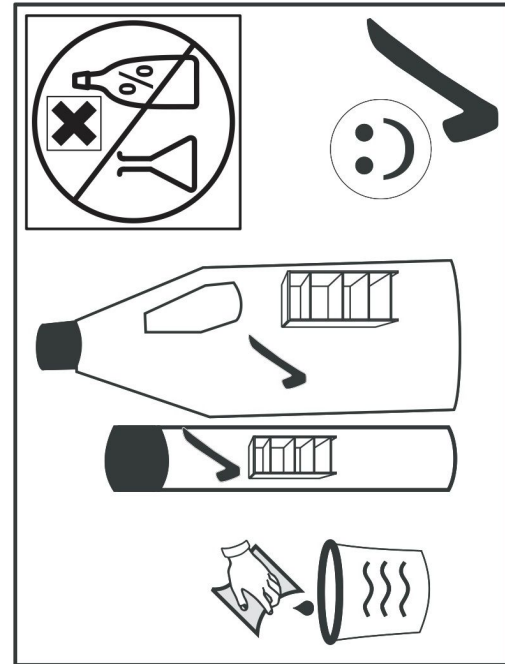
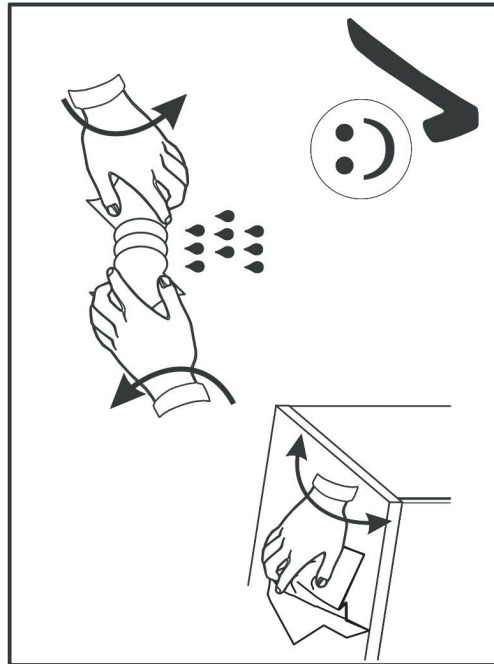
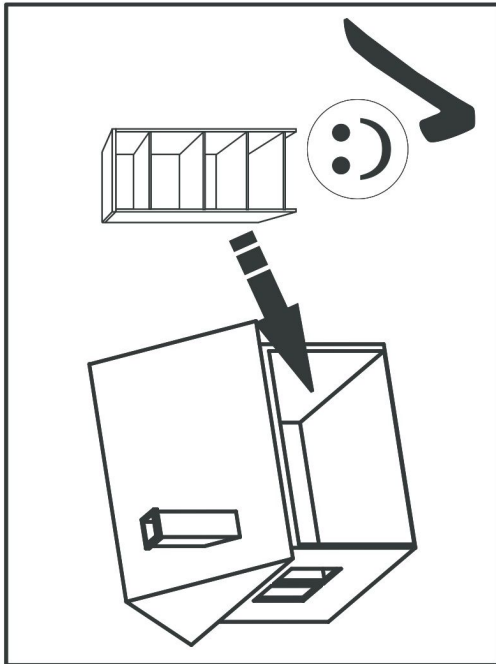
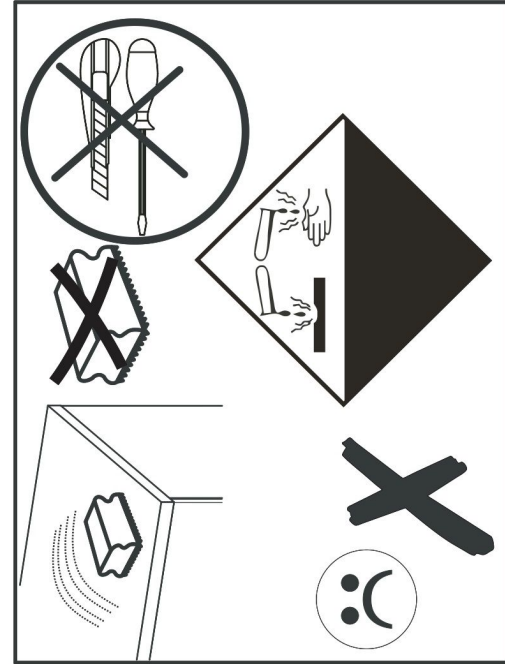
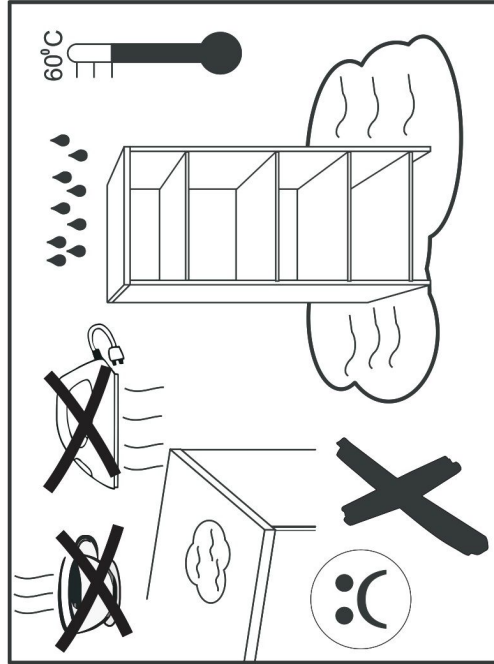
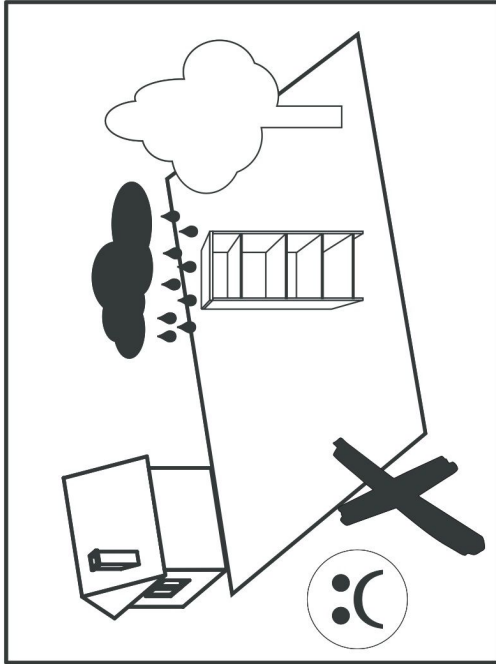
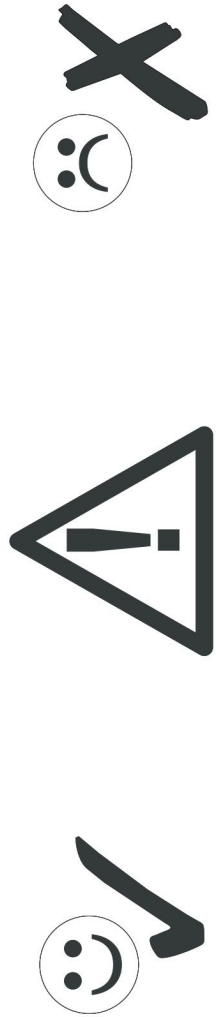

D CH AT LI LU
GB US
FR BE NC
NL
IT
SI
XS HR BA
HU
BG
CZ SK
SE
RO
ES

Kleintelle und Verpackungsfolien bei der Möbelmontage von Kindern fernhalten!
Keep small parts and plastic film out of the reach of children!
Tenir les petites pièces et les films plastiques hors de la portée des enfants!
Houd de kleine onderdelen en de plastic folie uit de buurt van kinderen!
Tenere i componenti di piccole dimensioni e le pellicole di plastica fuori dalla portata dei bambini!
Majnhn delov i embalazne folije pri montaži pohišnega namēštaja hranite dosega otrok!
Male dijelove i foliju za pakovanje priklom montaže namēštaja držite dalje od djece!
Bijorszerelés közben a kis alkatrészek és a csomagoló fóliák gyermekkektől távol tartandók!
Дребни детайли и опаковъчни фолия да се държат далеч от деца при монтажа на мебелите!
Pri montaži nabuyki uchovavajte drobné dily a obalové fólie z dosahu dětí!
Vid möbelmontering ska smäddeklar och förpackningsfolien hållas oåtkomliga för barn!
Tineit departe de copii piesele mici și folia de ambalat la montarea mobilierului!
iDurante el montaje, mantenga alejados de los niños las piezas pequeñas y el material plástico de embalaje!

D CH AT LI LU
GB US
FR BE NC
NL
IT
SI
XS HR BA
HU
BG
CZ SK
SE
RO
ES

Möbelmontage muss auf ebenem Untergrund erfolgen. Bei Wandmontagen immer geeignetes Befestigungsmaterial verwenden.
Furniture must be assembled on a flat surface. For assembly to the wall only use suitable fixing materials.
Le meuble doit être monté sur une surface plane. Pour le montage mural, utilisez des accessoires de fixation adaptés au type de mur.
De meubels dienen op een vlakke ondergrond te worden gemonteerd. Voor wandmontage moeten geschikte bevestigingsmaterialen worden gebruikt.
Il montaggio dei mobili deve avvenire su un fondo piano. Per il montaggio si prega di utilizzare solo materiali adatti.
Pohišstvo je treba montirati na ravni podlagi. Pri stenski montaži vedno uporabite pritrditveni material.
Nameštaj se mora montirati na ravnoj podlozi. Kod montaže na zid uvijek koristite prikladn materijal za pričvršćivanje.
A bútorszerelésnél sikk felületen kell végezni. Falra szereléshez mindig megfelelő rögzítanyagot kell használni.
Материят на мебелите да се извършва на равна основа. При стънен монтаж виняги да се използва подходящ крепежен материал.
Montáž nabuyki provádějte na rovném podkladu. Při montaži na stěnu používejte vždy vhodný příslušenací materiál.
Montering av möbeln måste göras på jämnt underlag. Vid väggmontering ska lämpligt uppfästingsmaterial användas.
Montarea mobilier trebuie să se realizeze pe o pardoseală dreaptă. La montarea la perete utilizați întodeauna material de fixare adecvat.
El montaje debe efectuarse sobre una superficie uniforme. En el montaje mural emplee siempre el material de fijación adecuado.

D CH AT LI LU
GB US
FR BE NC
NL
IT
SI
XS HR BA
HU
BG
CZ SK
SE
RO
ES

Bitte beachten Sie die Montageanleitung. Halten Sie immer die angegebene Wattzahl ein. Verhindern Sie einen Hitzestau.
Please observe the assembly instructions. Do not exceed the max. given wattage. Ensure that the heat is not allowed to build up.
Veuillez respecter la notice de montage. Respectez impérativement le nombre des watts maximal. Veillez à éviter toute accumulation de chaleur.
Lees a.u.b. de montagehandleiding door. Houd u beslist aan het max. opgegeven wattage. Zorg ervoor dat geen hittehuwling onstaat.
Attenersi alle istruzioni di montaggio. Rispettarsi rigorosamente il numero di watt max. indicato. Assicurarsi che non si verifichi un accumulo di calore.
Upoštevajte navodila za montažo. Vedno upoštevajte navedeno število vatov. Preprečite zastoj vročine.
Obratite molino Vas pozor na uputu za montažu. Uvijek se pridržavajte navedenog broja vati. Izbjegavajte zastoj vrućine.
Vegye figyelembe a szerelési útmutatót. Mindig tartsa be a megadott wattszámot. Akadályozza meg a hőfelgyűlést.
Мощ, вземете под внимание ръководството за монтаж. Спазвайте виняги посочените ватове. Избягвайте акумулиране на топлина.
Dodržujte prosim návod k montáži. Vždy dodržujte uvedenu hodnotu výkonu (watt). Zabráňte tak přehřívání.
Fóji monteringsanvisningen. Följ alltid angivet watttal. Undvik att hetta uppstår.
Respectați instrucțiunile de montaj. Respectați întodeauna numărul de wați impus. Evitați acumularea de căldură.
Le rogamos que tenga presente las instrucciones de montaje. Respete siempre el número indicado de vatios. Evite la acumulación de calor.

D CH AT LI LU
GB US
FR BE NC
NL
IT
SI
XS HR BA
HU
BG
CZ SK
SE
RO
ES

Halten Sie die max. zulässigen Belastungswerte der Möbelteile ein. Details siehe Montageanleitung
Comply with the max. permissible loads. For details, please refer to the assembly instructions
Respectez les valeurs de charge max. admissibles des parties de meubles. Pour plus de détails, cf. la notice de
Houd de maximaal geoorloofde belastingswaarden van de meubeldelen aan. Voor details verwijzen wij naar de montagehandleiding
Rispettare la portata max. permessa degli elementi del mobile. Per dettagli si vedano le istruzioni di montaggio e si vada
Upoštevajte največjo dovoljeno obremenitev delov pohišva. Podrobnosti najdete v navodilih za montažo in na
Pridržavajte se maks. dovoljenih vrijednosti opterećenja elemenata namještaja. Detalje vidí u uputu za montažu
Tartsa be a birtorelemek max. megengedett terhelési értékét. A részleteket lásd a szerelési útmutatóban
Spazvajte maks. dopuštené hodnoty zatížení nábytkových dílů. Podrobnosti viz návod k montáži
Dodržujte max. přípustné hodnoty zatížení nábytkových dílů. Podrobnosti viz návod k montáži
Fóji max. tillåten belastning av möbeldelarna. Mer information finns i monteringsanvisningen
Respectați valorile de solicitare max. admise pentru corpurile de mobilier. Pentru detalii consultați instrucțiunile de montaj
Respete los valores máximos de carga admisibles para las piezas de los muebles. Consulte los detalles en las instrucciones

D CH AT LI LU
GB US
FR BE NC
NL
IT
SI
XS HR BA
HU
BG
CZ SK
SE
RO
ES

Zur Möbelaufbauung ein mit Wasser befeuchtetes, fusselfreies Baumwolltuch verwenden. Gereinigte Flächen immer trockenreiben!
To clean the furniture only use a water dampened lint-free cotton cloth. Once cleaned, always wipe the surfaces dry.
Utilisez un chiffon en coton non pelucheux humidifié avec de l'eau pour nettoyer les meubles. Séchez systématiquement les surfaces nettoyées en les frottant à sec!
Gebruik een met water bevochtigde, pluistvrije katoenen doek om de meubels te reinigen. Wrijf gereinigde oppervlakken altijd droog!
Per pulire il mobile utilizzare un panno di cotone inumidito d'acqua e che non perde pelucchi. Asciugare sempre le superfici che si sono pulite!
Za čišćenje pohišva uporabljajte vlažno bombažno krpo, ki ne pušča vlaken. Očiščene površine vedno obrišite do suhlega!
Za čišćenje namještaja koristite sa vodom navlaženu pamučnu krpu koja ne ispušta vlakna. Očiščene površine uvijek obrišite suhom krpom!
Bútorészlektáshoz vízrel benedvesített, nem szárazodó pamukkenőt használjon. A megtisztított felületeket mindig törölgje szárazra!
Za почистване на мебелите използвайте навлажнена с вода, неизгускаща влажна памучна кърпа. Почистените повърхности винаги да се изтриват до сухо!
K čištění nábytku používejte bavlněný hadr neuvoloňující vlákna, navlhčený ve vodě. Vyučštěné plochy vždy utřete do sucha!
För möbelförhöring används en luddfri bomullstuck fuktad med vatten. Rengörda ytor ska alltid torkas torra!
Pentru curățarea mobilier utilizați o lavetă din bumbac fără saame umezită cu apă. Suprafețele curățate se șterg întodeauna până se usucă!
Emplee un paño de algodón humedecido con agua y líbre de pelusa para la limpieza de los muebles. ¡Seque siempre las superficies que ha limpiado!